

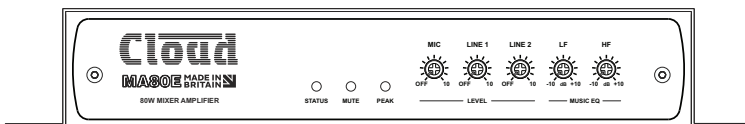

MA80E Mini Amplifier





 МУЗЦЕНТР
МУЗЫКАЛЬНОЕ ОБОРУДОВАНИЕ

<https://muzcentre.ru>

Installation and User Guide

WARNING:

To reduce the risk of fire or electric shock, do not expose this appliance to rain or moisture.

	<p>WARNING: SHOCK HAZARD – DO NOT OPEN AVIS: RISQUE DE CHOC ELECTRIQUE – NE PAS OUVIR</p>
	<p>The lightning flash with the arrowhead symbol within an equilateral triangle, is intended to alert you to the presence of uninsulated dangerous voltages within the product's enclosure that may be of sufficient magnitude to constitute a risk of electric shock.</p>
	<p>The exclamation point within an equilateral triangle is intended to alert the user to the presence of important operating and maintenance (servicing) instructions in the literature accompanying the appliance.</p>

IMPORTANT SAFETY INSTRUCTIONS

1. Read these Instructions.
2. Keep these Instructions.
3. Heed all Warnings.
4. Follow all Instructions.
5. Do not use this apparatus near water.
6. Clean only with a dry cloth.
7. Do not block any ventilation openings. Install in accordance with the manufacturer's instructions.
8. Do not install near any heat sources such as radiators, heat registers, stoves or other apparatus (including amplifiers) that produce heat.
9. Do not defeat the safety purpose of the polarized or grounding - type plug. A polarized plug has two blades with one wider than the other. A grounding type plug has two blades and a third grounding prong. The wide blade or the third prong are provided for your safety. When the provided plug does not fit into your outlet, consult an electrician for replacement of the obsolete outlet.
10. Protect the power cord from being walked on or pinched particularly at plugs, convenience receptacles, and the point where they exit from the apparatus.
11. Only use attachments/accessories specified by the manufacturer.
12.  Use only with the cart, stand, tripod, bracket or table specified by the manufacturer or sold with the apparatus, when a cart is used, use caution when moving the cart/apparatus combination to avoid injury from tip-over.
13. Unplug this apparatus during lightning storms or when unused for long periods of time.
14. Refer all servicing to qualified service personnel. Servicing is required when the apparatus has been damaged in any way, such as power-supply cord or plug is damaged, liquid has been spilled or objects have fallen into the apparatus, the apparatus has been exposed to rain or moisture, does not operate normally, or has been dropped.



Do not expose the apparatus to dripping or splashing, and ensure that no objects filled with water, such as vases, are placed on the apparatus.

L'appareil ne doit pas être exposé aux écoulements ou aux éclaboussures et aucun objet ne contenant de liquide, tel qu'un vase, ne doit être placé sur l'objet.



The mains plug is used as the disconnect device and it should remain readily accessible during intended use. In order to isolate the apparatus from the mains, the mains plug should be completely removed from the mains outlet socket.

La prise du secteur ne doit pas être obstruée ou doit être facilement accessible pendant son utilisation. Pour être complètement déconnecté de l'alimentation d'entrée, la prise doit être débranchée du secteur.



Terminals marked with the ⚡ symbol may use Class 2 Wiring, but voltages at these terminals may be of sufficient magnitude to constitute a risk of electric shock. The external wiring connected to these terminals requires installation by an instructed person or the use of pre-made leads or cords.



EU Declaration of Conformity

DATE OF ISSUE: 27th September 2018

MANUFACTURER: Cloud Electronics Limited

ADDRESS: 140 Staniforth Rd,
Sheffield,
S9 3HF. UK

PRODUCT NAMES: MA80EK, MA80NA, MA80AUS
MA80FTEK, MA80FTNA, MA80FTAUS
MA80EEK, MA80ENA, MA80EAUS

PRODUCT TYPE: Mini Mixer Amplifier

Cloud Electronics Ltd declare under our sole responsibility that the listed products comply with the requirements set out in the Council Directive **2014/35/EU** for electrical equipment used within certain voltage limits or Low Voltage Directive (LVD); and with the requirements of directive **2014/30/EU** for Electromagnetic Compatibility (EMC); and the CE Marking Directive **93/68/EEC & RoHS2 Directive 2011/65/EU**

For the evaluation of the compliance with these directives the following standards were applied:

Directive **2014/35/EU** (electrical equipment designed to be used within certain voltage limits);
Test Specification(s): **BS EN62368-1:2014**

Directive **2014/30/EU** (electromagnetic compatibility);
Test Specification(s): **BS EN55035:2017 (Immunity)**
BS EN55032:2015 (Emissions)
BS EN61000-3-2:2014 (Harmonics)

Cloud Electronics Ltd declare that the products produced under its brand name are designed and manufactured as professional audio products and therefore outside of the intended scope of the European Commission Regulations (EC) **1275/2008** of 17th Dec 2008 implementing Directive **2005/32/EC** of the European Parliament and of the Council with regards eco-design requirements for STANDBY and OFF mode electric power consumption of electrical and office equipment.

Place and Date Issued: Cloud Electronics Limited, 27th September 2018.

A handwritten signature in black ink, appearing to read 'Simon Curtis'.

Simon Curtis,
Managing Director

REACH Directive; it's expected that our suppliers and business partners be aware of their obligations under REACH. Given those conditions, our current products are exempt from REACH pre-registration and later registration activities. We provide a separate EU Reduction of Hazardous Substances document for our RoHS compliant products.

The WEEE directive (2002/96/EC) places an obligation on all manufacturers and importers, trading in the EU, to take back electronic products at the end of their life. Cloud Electronics Ltd accepts the responsibility to finance the cost of disposing of such products. All our products are marked with the WEEE symbol; this indicates that these products must NOT be disposed of with other waste.

This document may not be changed or copied without authorisation

CONTENTS

IMPORTANT SAFETY INSTRUCTIONS	3
SAFETY INFORMATION.....	9
Safety Notes regarding Installation.....	9
Conformities	9
RoHS and WEEE declaration	10
Safety Considerations and Information	11
Caution – High Voltage	11
Caution - Mains Fuse	11
Servicing.....	11
OVERVIEW	12
Introduction	12
Applicable Models.....	12
MA80E main features.....	13
What’s in the Box.....	14
BLOCK DIAGRAM.....	15
FRONT PANEL DESCRIPTION	16
REAR PANEL DESCRIPTION.....	17
Installation.....	19
Mechanical	19
Ventilation.....	20
MA80E: simple and advanced configurations	20
Connections and adjustments.....	21
Line inputs	21
Sensitivity & Gain Control.....	22
Music Level and EQ control.....	22
Line 1 Priority.....	22
Mic input.....	23
Mic gain adjustment.....	24
Mic level control	24
Mic EQ.....	24
Microphone priority.....	24
Speaker Output.....	25
Connecting to 100/70/25 V line systems.....	25
Auxiliary Output.....	25
Facility Port	27
Connecting an LM-2 or BT-1.....	28
Connecting an RL or RSL Series remote control plate	29

Using the Facility Port as an auxiliary input	30
Music Mute Input	31
Auto Power Down	32
Ethernet Control of the MA80E.....	33
OS and Browser compatibility	33
Checking browser compatibility.....	33
Configuring the network.....	33
Zone 1 page	37
Line Inputs tab.....	39
Mic Input tab.....	40
Room EQ tab.....	41
Music EQ tab.....	42
Speaker EQ tab.....	43
Auxiliary Out tab.....	45
Master tab.....	45
Configuration menu	46
User Security	46
Guest User	49
Change Installer PIN.....	49
Labelling.....	50
General Settings	50
Power-up Mode and Power-up Defaults.....	50
RS232 Baud Rate	51
Network	52
Save/Restore.....	53
Device Info.....	54
MA80E Serial Control	55
Pinout.....	55
Abridged command set	56
Examples:.....	56
Using the MA80E as an Ethernet-to-serial bridge	58
Appendix	59
PCB layout diagram	59
Table of internal jumpers and default settings.....	60
Summary of rear panel DIP switch functions.....	61
Troubleshooting – STATUS LED indications	62
Fault resolution.....	62
Earthing.....	63
Technical specifications	64

SAFETY INFORMATION

Safety Notes regarding Installation

- Do not expose the unit to water or moisture.
- Do not expose the unit to naked flames.
- Do not block or restrict any air vent.
- Do not operate the unit in ambient temperatures above 35°C.
- Do not touch any part or terminal carrying the hazardous live symbol ⚡ while power is supplied to the unit.
- Do not perform any internal adjustments unless you are qualified to do so and fully understand the hazards associated with mains-operated equipment.
- The unit has no user-serviceable parts. Refer servicing to qualified service personnel.
- If the moulded plug is cut off the AC power lead for any reason, the discarded plug is a potential hazard and should be disposed of in a responsible manner.

Conformities

This product conforms to the following European EMC Standards:

BS EN 55035:2017 (Immunity)

BS EN 55032:2015 (Emissions)

BS EN 61000-3-2:2014 (Harmonics)



This product has been tested for use in commercial and light industrial environments. If the equipment is used in controlled EMC environments, the urban outdoors, heavy industrial environments or close to railways, transmitters, overhead power lines etc. the performance of the unit may be degraded.

The product conforms to the following European electrical safety standard:

BS EN 62368-1:2014

This product is designed to be compliant with the relevant provisions of

ENERGY STAR® Eligibility Criteria Ver 3.0 for Audio-Video products.

RoHS and WEEE declaration

Cloud Electronics Limited manages its business and collaborates with its suppliers to comply with the European Union restriction of the use of certain hazardous substances in electrical and electronic equipment, RoHS Directive (2002/95/EC), that came into force on 1st July 2006, and similar restrictions in other jurisdictions.



The "crossed out wheeie bin" symbol on the product and represented here is there to remind users of the obligation of selective collection of waste. This label is applied to various products to indicate that the product is not to be thrown away as unsorted municipal waste. At the end of life, dispose of this product by returning it to the point of sale or to your local municipal collection point for recycling of electric and electronic devices.

Customer participation is important to minimize the potential effects on the environment and human health that can result from hazardous substances that may be contained in this product.

Please dispose of this product and its packaging in accordance with local and national disposal regulations, including those governing the recovery and recycling of waste electrical and electronic equipment. Contact your local waste administration, waste collection company or dealer.

Safety Considerations and Information

The MA80E amplifier must be earthed. Ensure that the mains power supply provides an effective earth connection using a three-wire termination.

Caution – High Voltage

Do not touch any part or terminal carrying the hazardous live symbol while power is applied to the unit. Terminals to which the hazardous live symbol refers require installation by a qualified person.

Caution - Mains Fuse

The internal PSU is a sealed unit and contains no user-replaceable fuses. Mains over-current protection is provided by the fuse in the AC mains plug, which should be rated at 5 A.

Servicing

The unit contains no user serviceable parts. Refer servicing to qualified service personnel. Do not perform servicing unless you are qualified to do so. Disconnect the power cable from the unit before removing the top cover and do not make any internal adjustments with the unit switched on. Only reassemble the unit using either the original bolts/screws, or ones identical to the original parts.

OVERVIEW

Introduction

The MA80E is a very compact stereo amplifier of advanced design, intended for integration into audio and AV systems where de-centralised installation is advantageous. It may be considered an “install-and-forget” component, and is small enough to be fitted into a wall or ceiling void, or in any convenient location adjacent to projectors, flat screen displays or loudspeakers, for example. It is highly suitable for use with in-store digital signage, gallery and museum exhibits and in fixed or mobile tour guide systems.

The MA80E can deliver 80 W (mono) into a 4 ohm load. It has two unbalanced stereo inputs for line level signals (typically music sources) and a balanced mic input for announcements, etc., with the usual Cloud priority options. Front panel preset-type controls are provided for music level and music EQ. There are also rear-panel preset adjustments, plus DIP switches on the rear panel and internal jumpers enabling various configuration changes to be made. A remote input module or remote level control can be wired to the amplifier’s Facility Port, which can also be used as an additional line input. An Ethernet port provides extensive remote configuration and control options using any compatible network device with a standard web browser. The MA80E may also be fully controlled using RS-232 commands.

The MA80E will operate “out of the box” in its basic configuration: the simple set of manual controls and configuration options makes it quick and easy to integrate into any audio system. Greatly enhanced control and configuration can be achieved through the internal web server, including control of the amplifier’s DSP section.

Applicable Models

This Installation Guide describes the installation and operation of the following model only:

- Cloud MA80E 80 W mono amplifier for 4 ohm loudspeakers

NOTE: Amplifier models MA80 and MA80FT are NOT covered by this Guide, and when installing either of these models, reference should only be made to the Guides specific to them.

MA80E main features

- Internal web server for simple and secure setup and control from any location
- Two (unbalanced) stereo line inputs with individual gain trims
- Electronically-balanced mic input with separate gain control
- 24 V phantom power selectable by internal jumper
- Front panel control of music and mic levels
- HF & LF EQ adjustments for music sources
- Rear panel HF & LF EQ for mic input
- Selectable LINE 1-over-LINE 2 priority
- Extensive set of DSP functions for advanced configuration
- Front panel controls are disabled when browser control is in use
- Facility port for connection of LM-2 or BT-1 remote input modules via screened Cat 5 cable; also allows remote control of music level and source
- 80 W (into 4 ohms) power amplifier
- Electronically-balanced auxiliary output, source selectable pre- or post-EQ
- Music Mute control input (N/O or N/C) for interface to emergency system
- Switchable high-pass filter for use with 100/70/25 V line systems (via external transformer)
- RS-232 port for full serial control; serial commands may also be sent via Ethernet
- Automatic power-down function (user-selectable)
- Less than 3 W power consumption in sleep mode
- Convection cooled – silent in operation
- Power requirements: 100 to 240 V AC, 50 to 60 Hz

Available Options:

- LM-2 remote mic/line input module with music volume control
- BT-1 Bluetooth wireless audio input module
- RL Series remote control plates (music level)
- RSL Series remote control plates (music level & source selection)
- 20 mm Flexible Conduit Adaptor Kit (Warepart CA947034) for permanent installations: replaces IEC receptacle

What's in the Box

Please check the shipping carton for damage before opening. If there is damage, please contact your Cloud agent and the shippers.

- The packing carton should contain the following items:
- MA80E amplifier
- IEC mains lead (AC cord) with moulded plug appropriate to the territory
- Set of mating plug-in screw-terminal connectors
- Set of four self-adhesive polyurethane feet
- This manual

BLOCK DIAGRAM

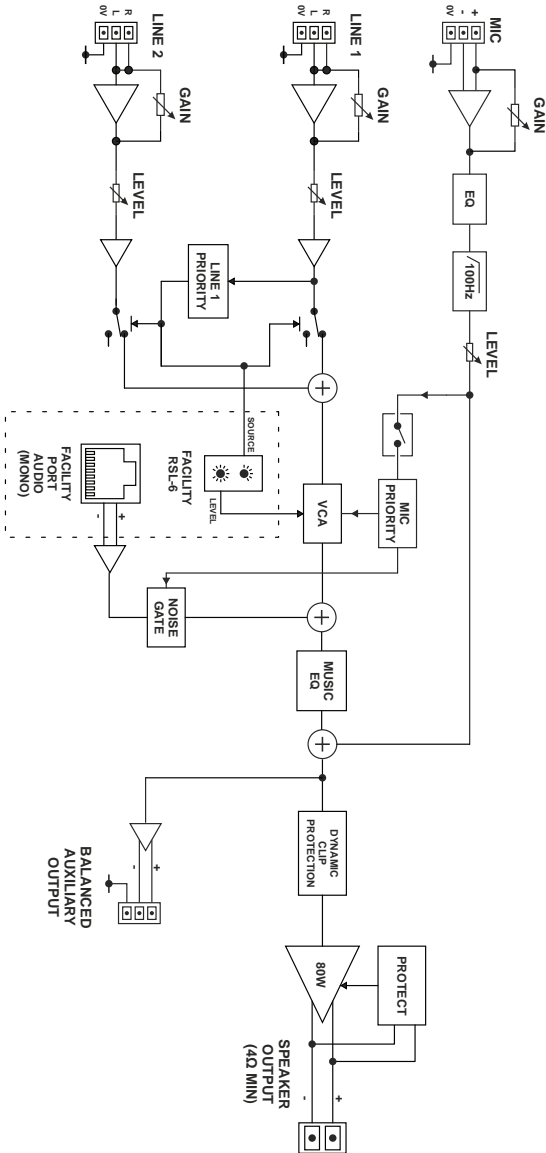

BLOCK DIAGRAM SHOWN IN "OUT OF THE BOX" MODE
 ADVANCED FEATURES SUCH AS SPEAKER EQ, ROUTING AND CONFIGURATION
 ARE AVAILABLE THROUGH THE WEB INTERFACE

FRONT PANEL DESCRIPTION

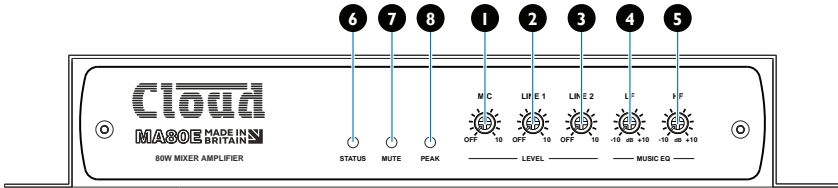

LEVEL controls:

1. **MIC** – adjusts volume of the signal connected to the **MIC** input.
2. **LINE 1**– adjusts volume of the signal connected to the **LINE 1** input.
3. **LINE 2** – adjusts volume of the signal connected to the **LINE 2** input.

MUSIC EQ controls:

4. **LF** – LF EQ adjustment of music channel: +/-10 dB @ 50 Hz.
5. **HF** – HF EQ adjustment of music channel: +/-10 dB @ 10 kHz.

6. **STATUS** – bi-colour LED: illuminates as follows:

- steady green - active
- steady red – sleep (APD) mode
- flashing green – fault condition (over-temperature, speaker wiring error or over-current); power-cycle to clear
- flashing red – fault condition (DC protection triggered); power-cycle to clear

Please see “Troubleshooting – STATUS LED indications” on page 62 for a full description of the above modes.

7. **MUTE** – red LED: illuminates when the MUSIC MUTE function is active
8. **PEAK** – red LED: illuminates if the amplifier’s dynamic clip protection becomes active

REAR PANEL DESCRIPTION

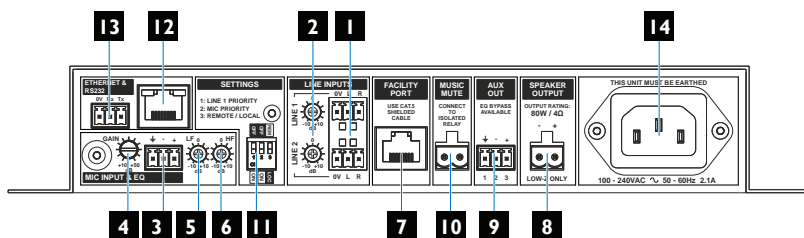

1. **LINE 1** and **LINE 2** – stereo line inputs for music sources (unbalanced).
2. **GAIN** – preset gain trim controls (+/-10 dB) for each line input.
3. **MIC INPUT** – balanced mic input.
4. **GAIN** – preset gain control for mic input; range +10 to +50 dB.
5. **LF** – LF EQ adjustment of mic signal: +/-10 dB @ 100 Hz.
6. **HF** – HF EQ adjustment of mic signal: +/-10 dB @ 5 kHz.
7. **FACILITY PORT** – RJ45 socket for connection of remote input/control modules such as the LM-2 and BT-1; it is also possible to connect an RL-1 or RSL-6 remote control plate to this port.
8. **SPEAKER OUTPUT** – amplifier output for low-impedance circuits.
9. **AUX OUT** – balanced line level output from pre-amplifier stage; post-EQ by default, may be selected to pre-EQ by internal jumper or via web interface.
10. **MUSIC MUTE** – connect to external N/O or N/C contacts for remote muting of music sources.
11. **SETTINGS** – three-pole DIP switch for setting various amplifier configurations:

SWITCH		FUNCTION
1	LINE 1 PRIORITY	Enables LINE 1-over-LINE 2 priority
2	MIC PRIORITY	Enables mic-over-music priority
3	REMOTE/LOCAL	Enables control of music volume and source selection via the FACILITY PORT .

See “Summary of rear panel DIP switch functions” on page 61 in the Appendix section for full details.

12. **ETHERNET** – standard RJ45 network port for connection to computer or other device; allows access to browser pages for remote control and configuration.
13. **RS232** – bidirectional serial control port
14. Power input – standard IEC receptacle for AC mains, voltage range 100 to 240 V, 50/60 Hz. May be replaced by the 20 mm Flexible Conduit Adaptor Kit (Warepart CA947034) for installations where it is desirable for the amplifier to be permanently connected to the mains supply.

INSTALLATION

Mechanical

The compact size and light weight of the MA80E combined with its high energy efficiency allows it to be installed in almost any location. It can be easily placed in ceiling or wall voids, or fitted to the rear of display screens or loudspeaker cabinets.

The amplifier has mounting flanges with keyhole slots to permit it to be secured on a horizontal or vertical flat surface.

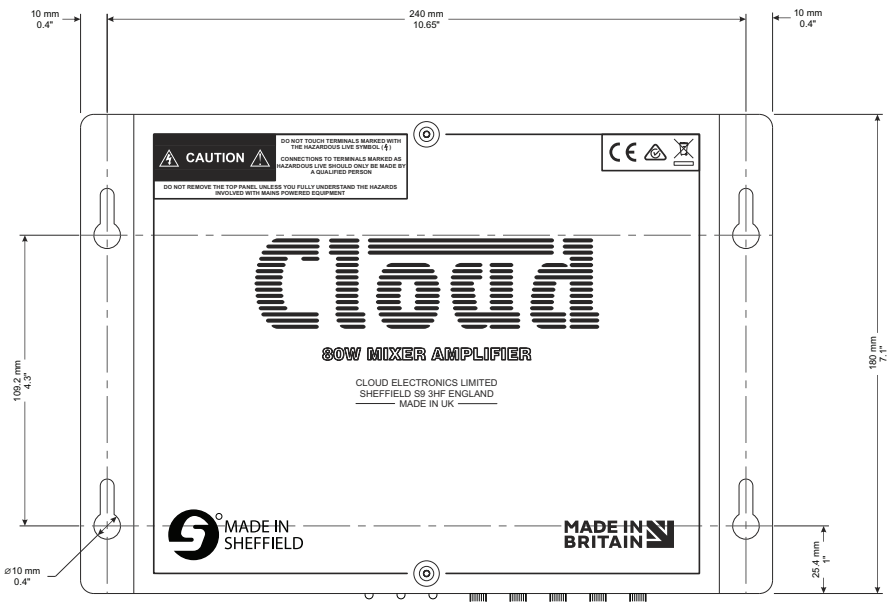

If using the MA80E in a free-standing situation, the self-adhesive feet (supplied with each amplifier) should be fitted. The amplifier should always be stood on a flat surface. Care should be exercised in selecting a location for a free-standing unit, which should allow ventilation but be clear of any liquid or similar hazard.

Ventilation

The MA80E uses natural convection cooling, and care should be taken to locate it where airflow is unrestricted (e.g., not under ceiling insulation material). Consideration should also be given to ease of access, should the operational configuration or audio levels need adjustment after installation.

In free-standing installations, always fit the polyurethane feet supplied, and do not stand any other items on top of the unit.

MA80E: simple and advanced configurations

The MA80E is designed to work "out-of-the-box", and for many installations its basic factory configuration will provide satisfactory and adequate operation. In such installations, an Ethernet connection need not be provided.

In other installations, the installer may wish to access the MA80E's DSP section to take advantage of the more sophisticated EQ it provides, and/or to make the amplifier's web control pages available to the user. For this reason, configuration and control via the Ethernet connection is covered in a separate section of this Guide: see "ETHERNET CONTROL OF THE MA80E" on page 33. Installers not requiring the additional functionality can ignore this section.

Connections and adjustments

Line inputs

The amplifier has two stereo line inputs **1**, each of which is mixed internally to mono; these inputs are suitable for most music sources such as CD/DVD players, satellite receivers and computer line outputs.

Both inputs are unbalanced and use 3-pin 3.5 mm-pitch screw terminal connectors. The connectors should be wired as follows:

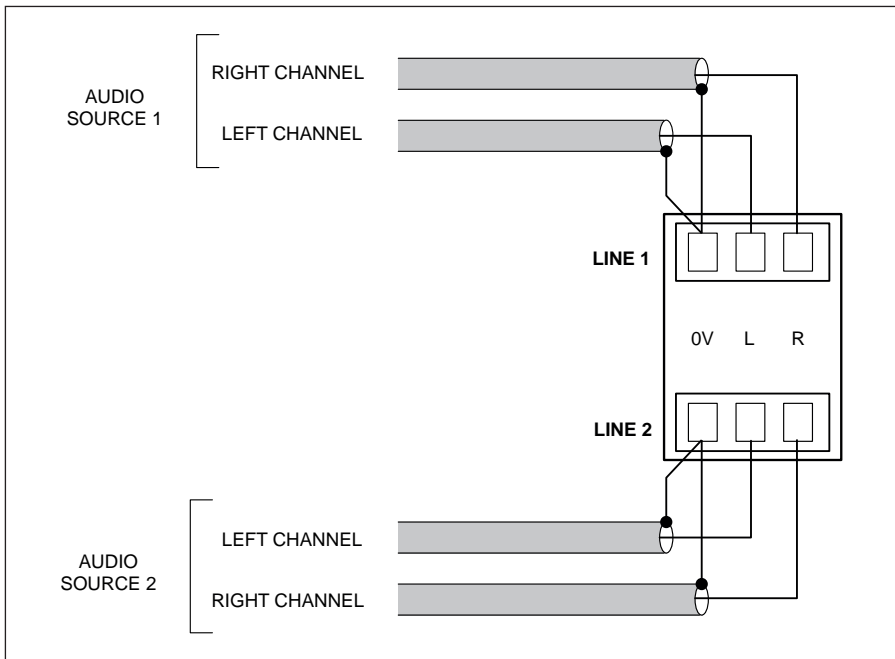

Unless a Cloud remote control plate or module such as the RSL-6 or LM-2 is in use, the two line inputs are summed together internally, though Line input 1 can be configured to have priority over Line input 2, see “Line 1 Priority” on page 22

Sensitivity & Gain Control

Each of the stereo line inputs has an input impedance of 10 kohms and a preset type gain control **2**, on the rear panel adjacent to the input sockets. The gain controls have a range of 20 dB allowing the input sensitivity to be varied from -12 dBu to +8 dBu (0 dBu = 0.775 Vrms). The gain controls should be set so that the input sources in use do not distort, and the front panel level controls **2** and **3** have a useful range.

Music Level and EQ control

The front panel **LINE 1** and **LINE 2** controls **2** and **3** should be adjusted during installation to set the volume of the audio sources. The line inputs are summed post the level controls; and equalisation can be applied using the front panel LF and HF controls **4** and **5**, which can apply a cut or boost of up to 10 dB at 50 Hz and 10 kHz respectively. If it is not intended to make use of the enhanced EQ adjustments available via the web interface, simply adjust the EQ controls by ear to suit the audio programme material being used, the speaker characteristics and the room acoustics. If the programme material includes speech, the EQ should be adjusted for best intelligibility.

If the line input levels are set too high, the amplifier's dynamic protection will activate to prevent clipping and the front panel **PEAK LED** **8** will illuminate to indicate this.

Line 1 Priority

When both line inputs are in use, one audio source can be given automatic priority over the other by connecting it to Line 1 input and setting rear panel **SETTINGS** DIP switch 1 (**LINE 1 PRIORITY**) to ON. This is a useful facility when a Digital Sound Store, emergency announcement system or similar source forms part of the audio system.

When Line 1 Priority is enabled, the amplifier will route the input signal at Line 2 normally until a signal is detected at Line 1's input. When this happens, it switches its music source automatically to Line 1. Once the signal at Line 1 stops (e.g., when an announcement finishes), Line 2's source will smoothly restore to its former level over approx. 3 seconds.

Mic input

The MA80E has a single microphone channel, enabling it to be used for announcements, commentary, karaoke or any other purpose requiring a microphone. By default, the mic channel is independent and is simply mixed with the summed line inputs, but may be reconfigured so that it has automatic mic-over-line priority. See “Microphone priority” on page 24 for more details.

The mic input **3** is a 3-pin 3.5 mm-pitch screw terminal connector. Use the wiring shown below.

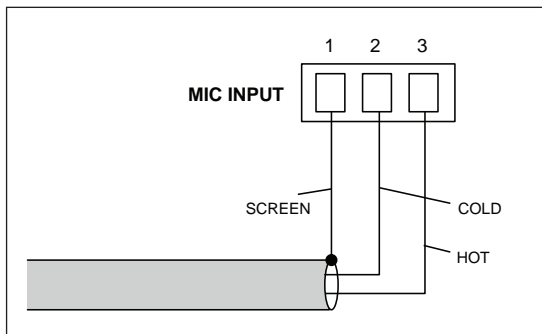

The MA80E’s microphone pre-amplifier is an electronically balanced, transformerless design configured for optimum low noise performance. The input impedance is greater than 2 kohms and is suitable for microphones in the 200 ohm to 600 ohm range. The microphone signal path includes a fixed high-pass filter. This attenuates the response below 100 Hz, which helps to reduce the effects of microphone handling noise.

24 V phantom power is available at the mic input, and is activated by setting internal jumper J6 to the ON position. See “PCB layout diagram” on page 59 for further information regarding the internal jumpers. Care should be taken to ensure that phantom power is enabled only when the microphone in use requires it – i.e., a capacitor or electret type: other types of microphones (such as dynamic) may be damaged if a DC voltage is applied to them.

Mic gain adjustment

The mic input has a preset gain control **4** adjacent to the input connector. The gain can be adjusted over a range of 40 dB, from 10 dB to 50 dB.

Mic level control

A front panel level control **1** is provided for the mic channel and this provides the user with a means of adjusting the volume of the microphone. The rear panel gain control **4** should be set at a level where distortion does not occur even when the front panel level control is fully clockwise. If the mic level is set too high, the front-panel **PEAK LED 8** will illuminate. Note that this LED also indicates excessive music level.

Mic EQ

The mic input has associated LF **5** and HF **6** EQ controls. These provide 10 dB of cut or boost at 100 Hz and 5 kHz respectively and should be adjusted by listening, to achieve a clear mic sound. The purpose for which the mic input will be used should be borne in mind when making adjustments.

Microphone priority

By default, the microphone channel is simply mixed with the music channel. It may be reconfigured with **SETTINGS** DIP switch 2 to have automatic priority over the music channel.

With **SETTINGS** DIP switch 2 – **MIC PRIORITY** - set to ON, a signal at the mic input will automatically mute both line inputs; typically this configuration should be selected to give announcements or commentary priority over background music. When the announcement is complete, the music channel fades back up to its previous level.

When ON, mic-over-line priority also has priority over Line 1 priority, meaning that a microphone announcement will always be heard, even if a Line 1 input is currently causing Line 2 to be muted.

Speaker Output

The power amplifier stage is fully protected against DC offset, PSU and amplifier over-current, and is also thermally protected. Activation of the protection circuitry shuts the power amplifier stage down until the fault condition clears. All protection conditions will automatically self-clear if the amplifier is power-cycled. A switch-on delay function mutes the output during power-up and power-down to protect loudspeakers.

The MA80E can deliver its rated power of 80 W into a 4 ohm load. When using multiple low-impedance loudspeakers (generally 8 ohms) with a single amplifier, series and parallel wiring should be employed to produce a total load impedance of not less than 4 ohms.

The low impedance output is available at the 2-pin 5 mm-pitch screw terminal **SPEAKER OUTPUT** connector on the rear panel **8**.

Connecting to 100/70/25 V line systems

The MA80E may be used to drive 100/70/25 V line loudspeaker systems if external transformers are employed.

When driving 100/70/25 V line loudspeaker systems there is a risk of transformer core saturation at high levels and low frequencies, which can produce distortion. To prevent this, the MA80E's output stage is provided with a variable frequency high-pass filter. The filter is enabled and adjusted via the internal web pages: see "Speaker EQ tab" on page 43 for details. We recommend that the filter is always enabled when the amplifier is used with 100/75/25 V line systems

Auxiliary Output

The amplifier is provided with an Auxiliary Output, **AUX OUT 9**. This may be used to drive an additional amplifier, for recording, or any other purpose where system "expansion" is required. The connector is a 3-pin, 3.5 mm-pitch screw terminal type.

The signal at the Auxiliary Output is balanced and at line level, and can thus be used to drive most external equipment directly. The connector pinout is identical to that used for the amplifier inputs:

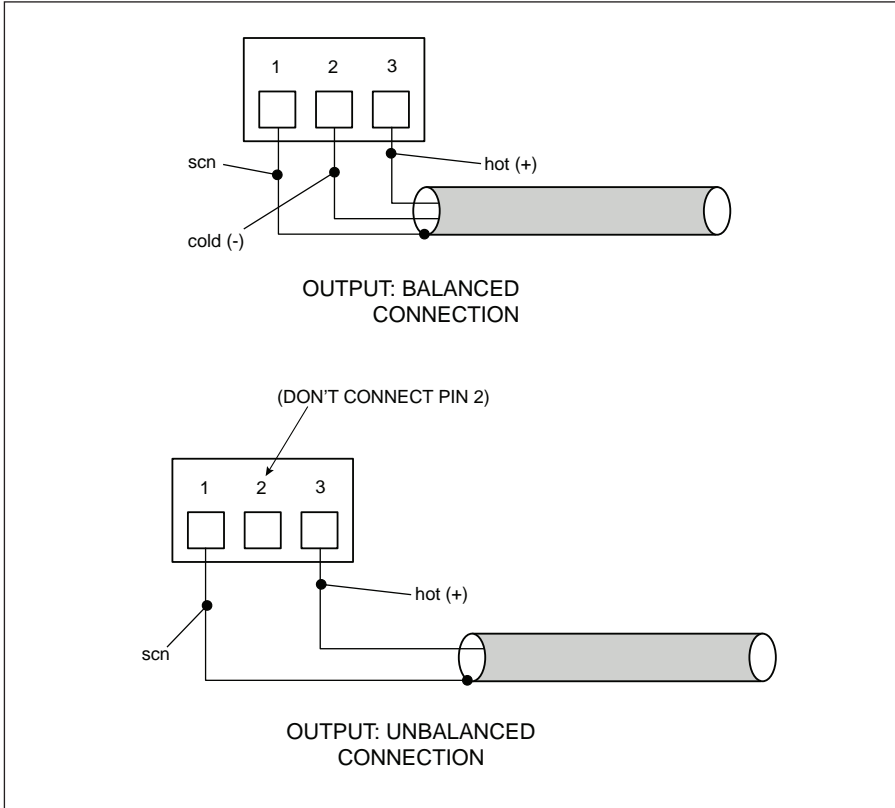

The “out-of-the-box” factory default source for the Auxiliary Output is taken from the input to the power amplifier stage, and will thus consist of the same mix of line and mic inputs, and will be affected by both Line 1 and Mic Priorities.

This means that by default the source is derived “post” the front panel MUSIC EQ controls. In some installations, it may be desirable to ensure that the EQ controls only affect the output to the loudspeakers connected to the amplifier’s main output and not the Auxiliary Output as well. This can be achieved through the web interface. See “Ethernet Control of the MA80E” on page 33 for more details.

Note that the Auxiliary Output is not affected by either the variable frequency high-pass filter, nor any speaker-specific EQ, both of which are also enabled using the web interface.

Facility Port

The MA80E amplifier is provided with a **FACILITY PORT** in the form of a rear panel RJ45 connector **7**. The primary use of the Facility Port is for the connection of an LM-2 or BT-1 remote active module, but it may also be used to connect RL and RSL Series remote control plates, or as a general-purpose mono auxiliary balanced input (see "Using the Facility Port as an auxiliary input" on page 30 for more information on this application)

The active modules operate from DC power supplied by the MA80E. The current consumed by each module is minimal and in the vast majority of installations there will be no power supply issues.

IMPORTANT: In order for the remote control functions on an LM-2 module or an RL/RSL Series plate to operate, **SETTINGS DIP switch 2 (REMOTE/LOCAL)** must be set to REM. The front panel LINE 1 and LINE 2 controls remain operational and we recommend that they are set to maximum to ensure a full range of level control is available from the remote module or plate. LINE 1/LINE 2 selection will also be available from an LM-2. However, it should be noted that the front panel level controls and the level and/or source selection controls on a remote control module or plate connected at the Facility Port will be disabled if the corresponding web browser controls are enabled; see "Input Routing tab" on page 39 for full details.

DIP switch 2 should remain set to LOC when a BT-1 is connected to the Facility Port.

The pinout of the Facility Port connector is given in the table below:

PIN	USE	CAT 5 CORE*
1	Audio 'cold' phase (-)	White + Orange
2	Audio 'hot' phase (+)	Orange
3	Priority VCA control	White + Green
4	+12 V	Blue
5	0 V	White + Blue
6	-12 V	Green
7	Music level control (0 to 3.3 V)	White + Brown
8	Music source select control (0 to 3.3 V)	Brown
SCN	GND ref for system music controls	Connector shell

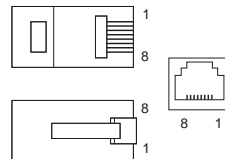

* Standard colour coding for pre-made cables

Connecting an LM-2 or BT-1

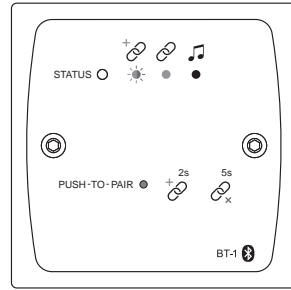
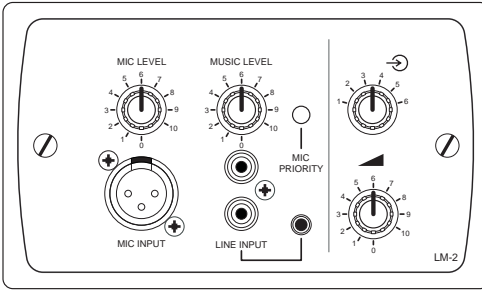

The LM-2 is an active input module which allows a microphone and a stereo line input in a remote location to be connected to various Cloud host units, including the MA80E. The module also includes the functions of a Cloud RSL-6 Remote Control Plate, which allows remote control of the MA80E’s music level and selection of Line 1 or Line 2 as the music source.

The BT-1 is a Bluetooth remote audio input module which enables compatible portable devices such as laptops, tablets and smartphones to stream audio wirelessly to the module, and thus into the audio system of the area where the module is installed.

NOTE: The MA80E is only compatible with the BT-1F variant of the BT-1: do not attempt to connect variant BT-1E.

The LM-2 or BT-1 should be connected to the MA80E’s **FACILITY PORT** using screened Cat 5 cable. (Note that as the cable carries analogue audio, only **screened** Cat 5 should be used.) The LM-2 includes controls for local music level and source selection, the wiring for these functions being catered for on the Facility Port. The maximum total Cat 5 cable length should not exceed 100 m.

LM-2: The LM-2’s upper PCB is fitted with an RJ45 connector labelled **OUTPUT**. Connect this to the **FACILITY PORT** using screened Cat 5 cable with screened RJ45s at each end. Follow the colour coding shown on page 27. The metal screening of the connectors should be bonded to the screen of the cable. Full details can be found in the LM-2 Installation Guide.

Before the LM-2’s music source and level controls will operate, set **SETTINGS** DIP switch 2 to REM. When used with an LM-2, the front panel **LINE 1** and **LINE 2** controls **2** and **3** determine the maximum music volume available: we recommend they are set so that when the **MUSIC LEVEL** control on the LM-2 is set to maximum, the volume is no higher than that required. Positions 3 to 6 on the LM-2’s Music Source switch have no function on the MA80E; selecting these positions will effectively mute both line inputs.

BT-1: Connect the RJ45 socket on the rear of the BT-1 to the MA80E's **FACILITY PORT** with *shielded* Cat 5 cable and shielded RJ45 plugs. Full details can be found in the BT-1 Installation Guide.

Connecting an RL or RSL Series remote control plate

The MA80E is also compatible with standard Cloud remote control plates of the RSL Series (music source select and level), and RL Series (level only). The MA80E differs from most other Cloud products in that it does not have a dedicated 3-pin "Remote Control" port: RL and RSL Series plates must instead be connected to the Facility Port. This is most easily accomplished by using shielded Cat 5 cable between the MA80E and the remote control plate, but only connecting the one (or two) cores concerned with the remote control functions (see pinout table on page 4727), plus the screen, to the plate.

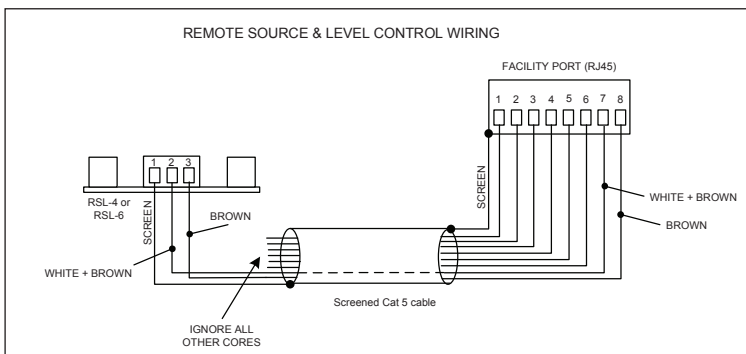
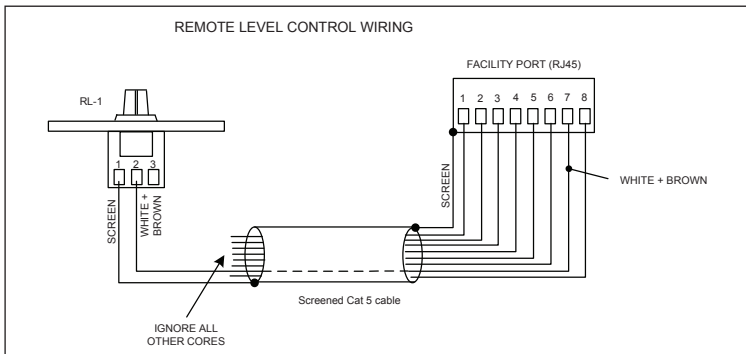

Using the Facility Port as an auxiliary input

The Facility Port provides a mono balanced audio input. If the port is not connected to a remote input module or remote control plate, it may be used as an additional, balanced line input. The signal applied at the Facility Port is mixed with the other inputs (LINE 1 and LINE 2), but has no independent level control on the amplifier; the signal level must be adjusted at the source.

Connect an external balanced source to the Facility Port as shown below:

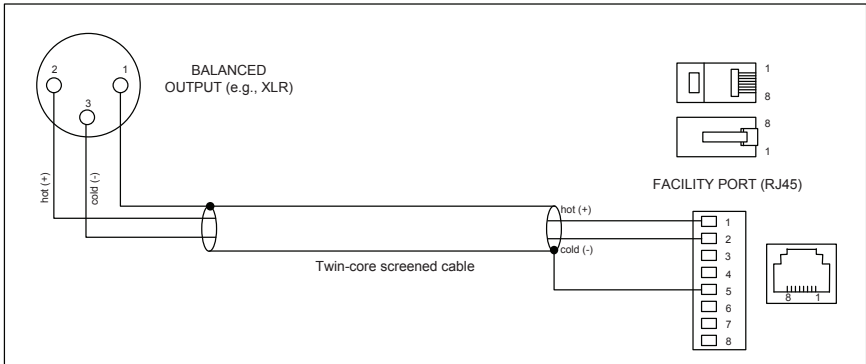

An unbalanced source may also be connected; the use of balancing transformers is recommended.

Music Mute Input

External muting of music may be commanded through the **MUSIC MUTE** connector. National or Local Authority regulations governing installed audio systems may require that normal programme material (i.e., music) should be muted in an emergency, to ensure that any evacuation messages are clearly audible. When active, it mutes all line inputs (including that at the Facility Port), leaving the microphone input active.

The Music Mute input is on a 2-pin 5 mm-pitch screw-terminal connector. It should be connected to the appropriate alarm output on whichever building management system registers the alarm (typically the Fire System). The alarm output must be volt-free; if no such output is available, an intermediate relay or other isolation device must be installed between the alarm output and the Music Mute input.

The Music Mute input can be set to operate on either normally open (N/O) or normally closed (N/C) contacts via internal jumper J5 (see “PCB layout diagram” on page 59). The factory default setting is N/O, thus requiring a short-circuit to be applied across the two pins of the connector for muting to occur.

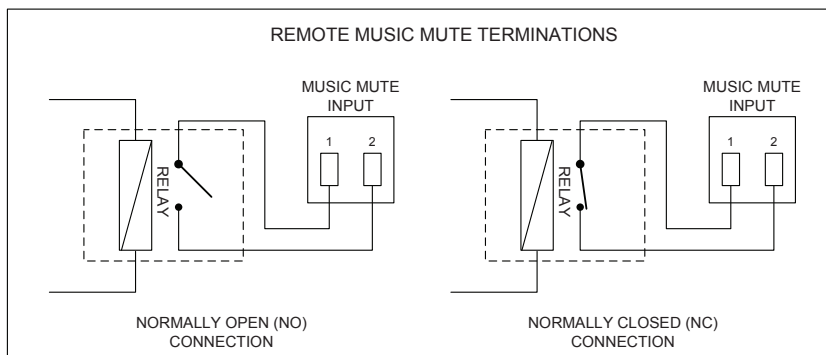

Auto Power Down

The MA80E is an extremely energy-efficient amplifier, but can be made even more so by enabling the Auto Power-Down feature. When active, the signal level is constantly monitored and if no input signals are measured for 25 minutes the amplifier enters a “Sleep” mode, minimising power consumption. If an input signal is detected while the channel is in this mode, the amplifier “wakes up” in less than 450 ms: if the signal is a line input, the volume will be faded up over a period of three seconds.

The MA80E is shipped with the Auto Power Down function disabled. It may be enabled by removing internal PCB jumper J4. See page 59 for details of jumper locations.

ETHERNET CONTROL OF THE MA80E

The MA80E has a web server function, which makes control pages available in a browser running on any device on the same network as the amplifier. This permits easy configuration and real-time control of the MA80E from any convenient device on the network.

OS and Browser compatibility

The MA80E uses standard TCP/IP and UDP-based networking protocols, and is therefore broadly compatible with modern desktop and mobile operating systems.

Checking browser compatibility

The Web Browser-based user interface requires HTML5, CSS3, localStorage and WebSockets support, which are provided as standard in current Web browsers.

If there is any doubt regarding browser compatibility, Cloud recommends the use of the website html5test.com to check which features your browser supports.

Configuring the network

NOTE: This section of the manual is intended for those with a working understanding of basic computer network configuration and the terminology involved.

Ethernet connection to the MA80E can be simplified by the use of the Cloud Ethernet Discovery Tool. This can be downloaded from www.cloud.co.uk; navigate to **Resources** and select **Downloads** in the resource selector. The Discovery Tool is available in two distinct versions:

- an executable JAR file, which will run on Linux, Windows or Mac systems within a Java Runtime Environment (available from www.java.com)
- a Windows-specific application, which does not require Java.

Download the most appropriate version for your operating system, and save it in a convenient location.

During initial setup, the MA80E may be connected directly to a laptop Ethernet interface, using either a straight or crossover Ethernet cable. In this scenario, both the laptop and MA80E will configure themselves using Link-local IP addresses and will be able to communicate without the requirement for DHCP, or further network infrastructure. Using this temporary connection, the MA80E can be set up and configured to use either DHCP (the default) or a specific, static IP address suitable

for the target network. If a static IP address is to be used, Subnet Mask and Gateway must also be set correctly. If Gateway details are unknown, the value 0.0.0.0 can be used safely.

Alternatively, the MA80E may be connected to a spare port of an Ethernet switch on an existing network, and set up from any device on the same network. In this scenario, DHCP is the expected method for IP address allocation during the initial setup procedure. If the network does not support DHCP, then the direct-connection method described above should be used to assign the correct static IP address first.

Run the Discovery Tool; this will open the window shown below, which should contain an entry with the host name **MA80E**.

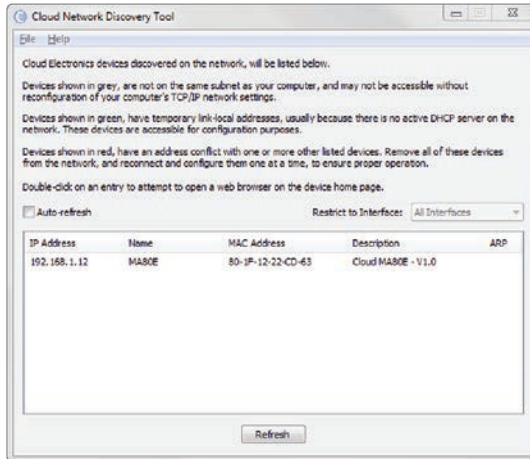

NOTE: If a warning message appears referencing Windows Firewall, it can be safely ignored by closing the message box.

Double-click on the MA80E entry. This should open your default browser and make the MA80E login page visible. The first page to be displayed on initial connection will be the PIN entry page; enter the Installer PIN (the factory default is 1234¹) to authorise access.

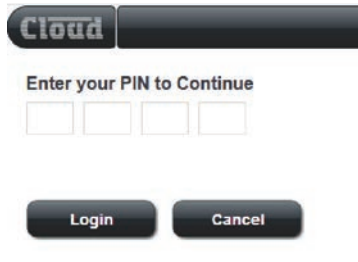

Click **Login** and the **Zone 1** page² will be displayed, with the **Line Inputs** and **Master** tabs open:

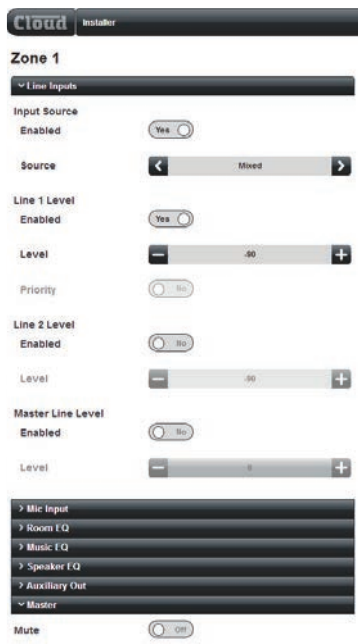

1. It is recommended that the factory default PIN is changed to something less obvious when installation is complete.
2. The web browser pages have been designed as a generic software application covering multiple Cloud products: although the MA80E only supports a single Zone, the Zone numbering system is retained.

NOTE: For security, the server has a time-out of two minutes; if no browser activity occurs within this time, it reverts to the login page and the PIN will need to be re-entered.

☰ Click the menu icon at the right-hand end of the **Installer** banner and now select **Config**, followed by **Network**. This will open the **Network Configuration** page:

Cloud Installer

Network Configuration

▼ TCP/IP Address

DHCP On

IP Address

Subnet Mask

Gateway

▼ Identity

Unit Name

▼ Server Ports

HTTP Port

Bridge Port

TCP Parser Port

UDP Parser Port

Multicast Off

Multicast Address

We recommend that the MA80E should either be set with a static IP address (i.e., with **DHCP** disabled), or uses a fixed DHCP allocated-address on your routing hardware. It will then have a fixed IP address on the network for other devices to browse to. Ensure that a suitable IP address is reserved on the network to which you intend to connect the device. If the MA80E changes IP address, users or third-party control applications may not be able to locate it. (Installers may need to consult the client’s IT Manager for guidance.)

Note that when **DHCP** is enabled, values for **IP Address**, **Subnet Mask** and **Gateway** are set automatically and the fields are no longer modifiable.

MA80E browser control

Once the network has been set up as described above, most of the MA80E's functions may be controlled remotely from a web browser running on a computer or other device anywhere on the same network.

Click the menu icon  on the title bar at any time to see the main drop-down menu.

Zone 1 page

Control and configuration of the MA80E's audio functions is done via the **Zone 1** page. The page is divided into seven tabs: **Line Inputs**, **Mic Input**, **Room EQ**, **Music EQ**, **Speaker EQ**, **Auxiliary Out** and **Master**. You can open or close any of the tabs by clicking on the tab name bar.

MA80E functions under browser control are summarised in the enhanced block diagram:

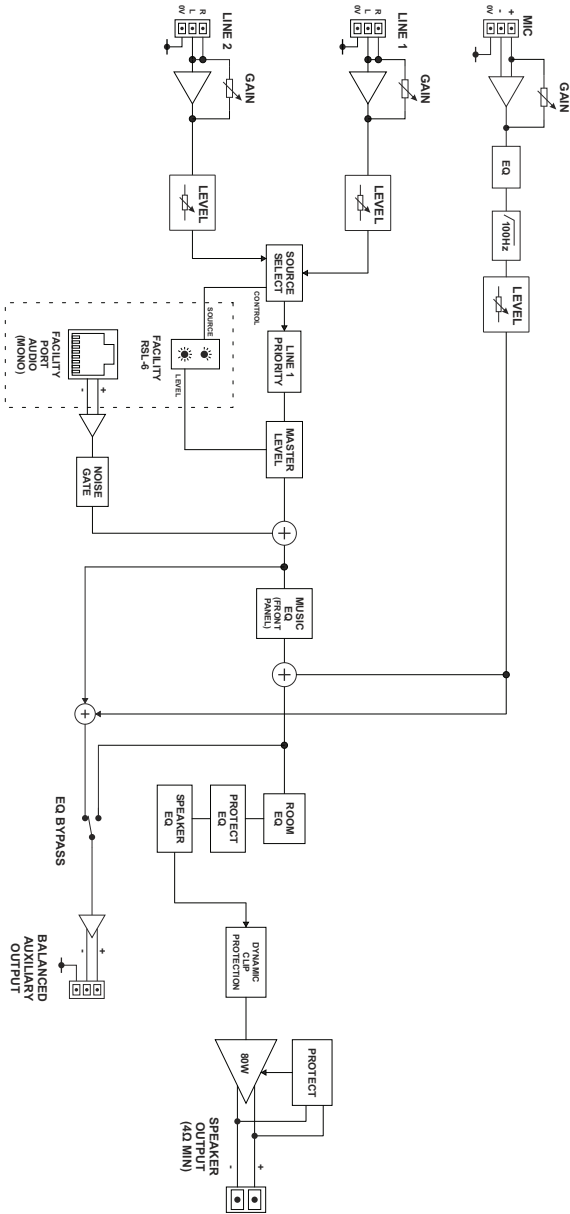

Line Inputs tab

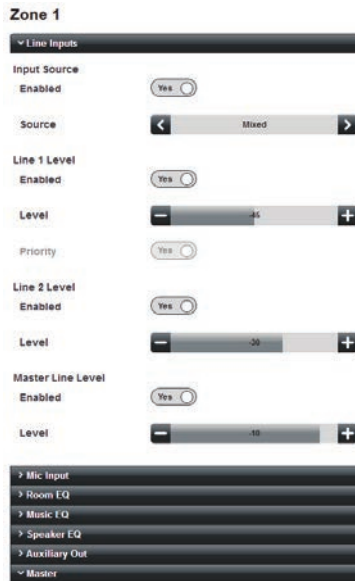

- Enabled** – each of the four slider controls on the **Line Inputs** tab has an **Enabled** switch. With the switch set to **Yes**, the associated slider is operative; in the **No** position, the slider is greyed out. In the case of the two Line Level sliders, setting **Enabled** to **Yes** disables the front panel level controls **LINE 1** ② and **LINE 2** ③.
- Input Source** – when enabled, click the < and > buttons of the **Source** slider to select the line inputs. **Mixed** is the default option: both Line 1 and Line 2 are enabled, and the two stereo inputs summed together internally. The other options are **Line 1** (Line 2 is disabled), **Line 2** (Line 1 is disabled) and **Off** (both Line 1 and Line 2 are disabled). An audio source connected to an LM-2 remote input module via the Facility Port will be mixed with Line 1 and/or Line 2, unless Full Priority has been enabled on the LM-2 itself, in which case both Line 1 and Line 2 will be muted. This also applies to the BT-1 remote input module, which automatically activates the Facility Port’s priority circuitry as soon as audio is streamed.
- Line 1 Level** - when enabled, click the + and – buttons of the Level slider to adjust the level of the Line 1 input signal. (Note that the buttons do not auto-repeat.) The scaling is in dBs, with 0 representing maximum; the

horizontal bar indicates the setting of the level control. When greyed out by setting **Enabled** to **No**, the bar continues to reflect to position of the front panel **LINE 1** control **2**.

- **Line 2 Level** – operates in an identical manner for Line Input 2.
- **Priority** – this switch is a mimic of rear panel DIP switch 1 – **LINE 1 PRIORITY**. It is always greyed-out and only reflects the setting of the physical switch.
- **Master Line Level** – when enabled, the **Level** slider adjusts the level of the summed signals at Line Input 1, Line Input 2 and any line input applied to the Facility Port. Default setting is 0, representing maximum level.

Mic Input tab

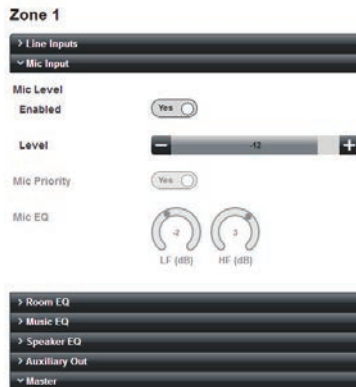

- **Enabled** – when set to **Yes**, the **Level** slider is operative and the front panel **MIC** control **1** is disabled. In the **No** position, the slider is greyed out.
- **Level** – when enabled, adjusts the level of the signal at the microphone Input. The mic signal is mixed with the music channel (the Line inputs plus the Facility Port input).
- **Mic Priority** – this switch is a mimic of rear panel DIP switch 2 – **MIC PRIORITY**. It is always greyed-out and only reflects the setting of the physical switch.
- **Mic EQ** - these on-screen rotary controls are not active: they are mimics of the physical rear panel Mic EQ controls **5** and **6**. Although greyed out, the mimics are always visible, and the physical controls themselves are always active.

Room EQ tab

The Room EQ section provides a flexible equaliser allowing the installer to optimise the amplifier to the room acoustics and programme material. Room EQ affects both music and mic signals. The EQ has “basic” and “advanced” modes.

The EQ section is placed in circuit and the controls made visible by setting the **Enabled** switch to **Yes**. With **Advanced mode** set to **Off**, the basic controls are displayed:



In Basic mode, simple treble and bass shelving filters are provided. The controls have a range of +/-12 dB at frequencies of 10 kHz and 50 Hz respectively.

Setting **Advanced mode** to **Yes** makes additional controls visible:

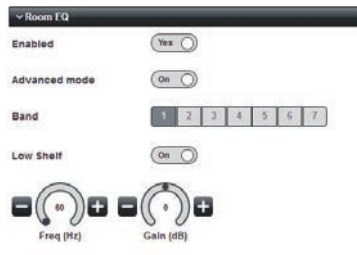

The Room EQ is now reconfigured as a seven band parametric equaliser, with peak/shelf switching on the highest and lowest bands. The Band buttons assign the rotary controls to each frequency band in turn: all bands have the same frequency range of 20 Hz to 20 kHz, adjusted by the **Freq (Hz)** control. However the seven default centre frequencies are 60 Hz, 250 Hz, 1 kHz, 2 kHz, 4 kHz, 8 kHz and 16 kHz, which will be suitable for most installations. The **Gain (dB)** control has a range of +/- 12 dB.

For Bands 2 to 6, a **Q** control replaces the **Low Shelf** (Band 1) or **High Shelf** (Band 7) switch:

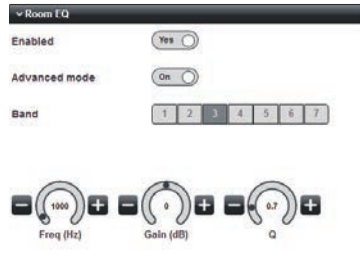

The **Q** control adjusts the bandwidth of the peaking filter over a range of 0.3 (broad) to 3 (narrow).

Bands 1 and 7 have **Low Shelf** and **High Shelf** switches respectively, which convert the filters constituting these bands between peaking and shelving types. The default is with the shelving switch **On**; in this mode the **Q** control is removed as it has no function in a shelving filter.

Music EQ tab



The on-screen rotary controls on this tab are not active: they are mimics of the physical front panel controls. With the **Enabled** switch set to **Yes** (the default setting), the mimics are visible (though they are always greyed out) and the physical controls themselves are enabled. Setting **Enabled** to **No** disables the controls and places the EQ section “out of circuit”, resulting in a “flat” EQ response; this will generally be desirable if the Room EQ software controls are to be used.

Speaker EQ tab

The **Speaker EQ** tab has controls for a steep high-pass filter intended for loudspeaker protection and, when enabled, a further five-band parametric equaliser, which can be used to accurately tailor the amplifier's frequency response to match that specified by speaker manufacturers.



The default configuration is for both the protection filter and the EQ to be disabled.

Setting the **Protect Enabled** switch to **No** disables the high-pass protection filter and restores the amplifier's maximum frequency response. The high-pass filter is a variable-frequency, fourth-order type (slope 24 dB/oct), and has a frequency range of 40 Hz to 20 kHz. The default frequency is 65 Hz, which should be satisfactory for many models of 100/70/25 V line loudspeaker when the amplifier is used with an external transformer. The frequency is adjusted with the **HP Filter** control; use the + and – buttons to alter the value.

The Speaker EQ section is made active with the **EQ Enabled** switch. Setting this switch to **Yes** makes additional controls visible. The EQ section has "basic and "advanced" modes, selected with the **Advanced mode** switch. With the switch set to **Off**, two additional selector switches are displayed:

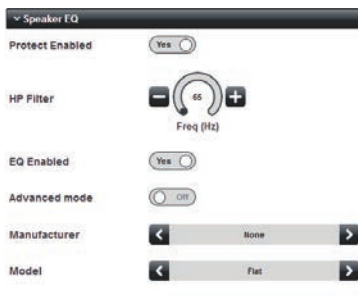

In this mode, it is possible to select a specific loudspeaker EQ preset from a set that has previously been installed. Installation of loudspeaker presets is via a firmware update.

Click on the < and > buttons of the **Manufacturer** and **Model** selectors to choose the preset required. Note that the default **Manufacturer** selection is **None**; in this case, the **Model** selector will display **Flat**, confirming that the Speaker EQ section will not modify the amplifier's frequency response. If no presets have been installed, **None** will be the only **Manufacturer** available.

If a preset is not available, but the installer has the manufacturer's recommended EQ settings for the loudspeaker being used, set the **Advanced** mode switch to **On**. This changes the control set as shown:

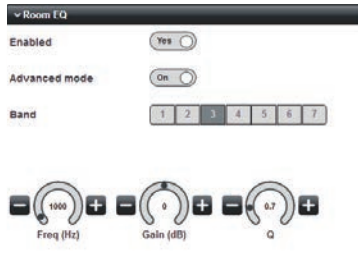

A five-band parametric equaliser is now available. The three rotary controls **Freq (Hz)**, **Gain (dB)** and **Q** adjust the frequency band selected by the **Band** buttons: use the + and – buttons to adjust the values. Default centre frequencies are 60 Hz, 250 Hz, 1 kHz, 4 kHz and 16 kHz, but may be set with the **Freq (Hz)** control to any frequency between 20 Hz and 20 kHz in each band. The default **Q** setting is 0.7 in all five bands, but may be set to any value from 0.3 to 3. The range of the **Gain (dB)** control is +/-12 dB.

Use the controls to set the EQ curve according to the manufacturer's data, which will usually be in the form of a number of dBs of cut or boost at specific frequencies. If a **Q** value is not provided, the default value of 0.7 may be taken as acceptable.

Auxiliary Out tab

The **Auxiliary Out** tab allows adjustment of the signal level at the **AUX OUT** connector **9** and also pre/post Music EQ selection of the source. The Aux Out signal is always the same mix of music and microphone inputs as at the amplifier's main output, but it is unaffected by any of the controls on the **Room EQ** or **Speaker EQ** tabs.

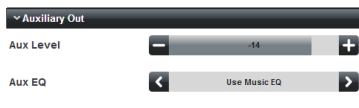

- **Aux Level** – adjust the output level in the same manner as the other on-screen level slider controls. The default level is 0, which represents maximum level (0 dBu).
- **Aux EQ** – this slider switch has two settings: **Use Music EQ** (the default), which sets the Aux Out signal to be sourced from immediately after the Music EQ section (see diagram on page 38); the front panel **MUSIC EQ** controls **4** and **5** will affect the Auxiliary Output in this case. The alternative setting is **Flat**, which sets the Aux Out source to be immediately before the Music EQ section; the front panel EQ controls will therefore not have any effect on the Aux Out signal.

Master tab

The **Master** tab provides a single control for the MA80E's output stage.



Set the **Mute** button to **On** to mute the amplifier's output. Note that the **Mute** button is within the amplifier's output stage, and thus affect all inputs, including the Facility Port.

Configuration menu

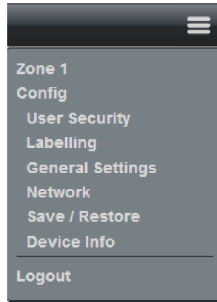

The **Config** Menu has pages concerned with global and network settings, definition of access privileges for different users and renaming options.

User Security

Expanding the **User Security** menu item opens the list of Users:

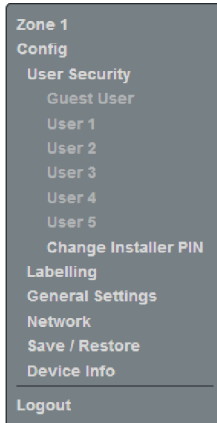

The MA80E security system allows up to five Users - in addition to the Installer - unique PIN access to the control pages. Additionally, a Guest User may access the

control pages without a PIN. Clicking on any of **User 1** to **User 5** opens the User privileges page for that User:

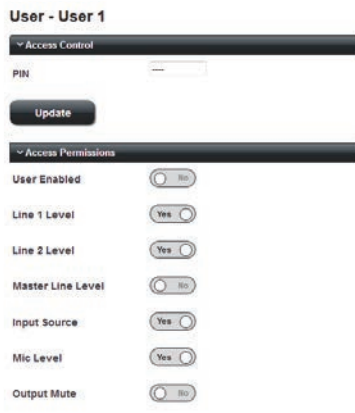

User - User 1

Access Control

PIN

Update

Access Permissions

User Enabled No

Line 1 Level Yes

Line 2 Level Yes

Master Line Level No

Input Source Yes

Mic Level Yes

Output Mute No

Note that only an Installer may define Users and change their access privileges.

The flexibility of the security system allows a client – if they wish - to give particular members of staff access only to certain control functions. Level control and/or source selection access privileges may be defined individually for each User.

To define User privileges, click in the **PIN** field under the **Access Control** tab, delete the default hyphens and then enter a PIN for the User. Click **Update** – a confirmation message will appear. The switches under the **Access Permissions** tab define the control functions that will be available for the User to control. **User Enabled** must be set to **Yes** to enable the new User PIN, and for the functions displayed below to take effect. Set the **Line 1 Level**, **Line 2 Level**, **Master Line Level**, **Input Source**, **Mic Level** and **Output Mute** switches to **Yes** or **No** as desired.

Once User privileges have been defined, the User(s) may log on using their own PINs, and will be presented with page layouts displaying only those functions which their access privileges allow. An example is shown below, where User 2 has been given access to input source selection and master line level but not to the individual input level adjustments.

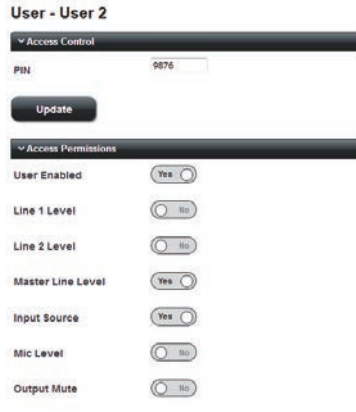

This will give User 2 the control page shown below:

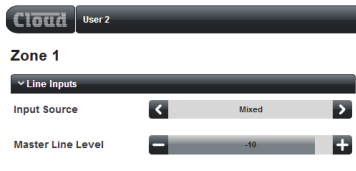

Users will see a main menu as below – note that most of the **Config** submenu options are not available.

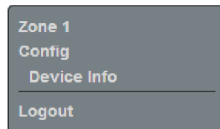

A User PIN may be changed by the Installer at any time from the **User Security** page for the specific User by deleting the current PIN – which will be displayed in the **PIN** field, entering a new PIN and clicking **Update** again. A confirmation message will be displayed.

Guest User

The security system provides for one additional User – the **Guest User**.

If **User Enabled** is active for the Guest User, it is possible to browse to the web interface pages without a PIN being requested. However, as with any other User, only those functions that have been assigned by an Installer will be available. The Guest User has been included to allow casual access to unit functionality without a PIN logon.

Change Installer PIN

Select **Change Installer PIN** from the menu to open the **Reset your PIN** Page.

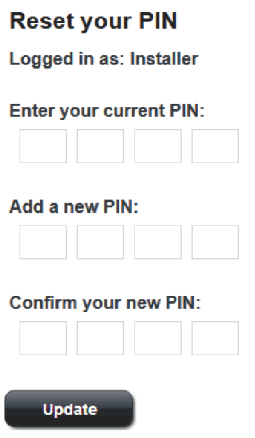

Reset your PIN

Logged in as: **Installer**

Enter your current PIN:

Add a new PIN:

Confirm your new PIN:

Update

This page lets you change the Installer PIN. You will need to confirm the current PIN in the **Enter your current PIN** field before proceeding to enter a new one in both the **Add a new PIN** and the **Confirm your new PIN** fields, and Click the **Update** button.

If the Installer PIN is forgotten or lost, a factory reset (see “Power-up Mode and Power-up Defaults” on page 50) will reset it to 1234.

Labelling

The **Labelling** page allows the Installer to change the names of the line inputs and the area covered by the amplifier (the default “Zone 1”). Names entered on the **Labelling** page will replace the default names on all browser pages where they appear. This provides a much more intuitive interface for both Installer and Users.

Renaming is simply a matter of selecting the default name in the field(s) and entering the new name(s). Clicking the **Upload** button will upload all the labels simultaneously; the names are loaded into non-volatile memory in the amplifier. The **Refresh** button reloads the **Labelling** page from the MA80E, and thus may be used to discard any changes that have been made to the labels on-screen since the last click of the **Upload** button.

General Settings

Power-up Mode and Power-up Defaults

It will often be desirable for the MA80E’s settings (input selections, levels, EQ settings, etc.), to be automatically restored to a known state when the unit is re-powered after being off for a period (intentionally or otherwise). The **Power Up Mode** function determines the state the MA80E “wakes up” in when it is powered-up.

The **Power-up Mode** button selects the active power-up option from the three available: **Factory**, **Default** and **Last Used**.

With **Factory** selected, the amplifier will return to its original factory settings at the next power-up. A list of factory settings can be found in the Appendix. If **Power-up Mode** is set to **Default**, the settings which have been saved in the Default memory (see below) will be restored. The third option, **Last Used**, will restore the amplifier settings to what they were when the unit was last powered off. This is the factory default option, and will be set at the first power-up after **Factory** is selected.

Use the **Save Defaults** button to store the amplifier's current state in the Default memory. With **Power-up Mode** set to **Default**, this will ensure that in the event of a power failure, the amplifier will resume a known, previously-defined state when power is restored. This is particularly important when a mixture of hardware control (front panel or remote plates) and browser control is being used.

The **Reset Defaults** button may be clicked to restore the Default memory to the original factory settings: this includes the disabling of all the browser controls. The Front Panel EQ controls are enabled. **Reset Defaults** will be most useful in resetting the MA80E's Default memory to a known initial "off" state.

RS232 Baud Rate

The default baud rate for the RS-232 serial port is 9600 baud. Use the **Baud Rate** < and > buttons to select an alternative if necessary. The rates available are 4800, 9600, 19200, 38400, 57600 and 115200 baud. For all baud rates, word structure uses 8 bits, one stop bit and no parity.

Note that the RS-232 baud rate setting only applies to the RS-232 port, not to serial commands sent via Ethernet.

Network

Select **Network** from the menu to open the **Network Configuration** page.

Network Configuration

▼ TCP/IP Address

DHCP On

IP Address

Subnet Mask

Gateway

▼ Identity

Unit Name

▼ Server Ports

HTTP Port

Bridge Port

TCP Parser Port

UDP Parser Port

Multicast on

Multicast Address

This page displays the network settings for the MA80E. The current **IP Address**, **Subnet Mask**, **Gateway** address and **Unit Name** are confirmed. If **DHCP** is set to **On**, the values in **IP Address**, **Subnet Mask** and **Gateway** are set automatically and the fields greyed out. If assigning these values (with **DHCP** set to **Off**), ensure that a suitable, reserved static IP address is used. This may require consultation with the network administrator.

Unit Name – this field has a default value of 'MA80E'. In an installation where several MA80Es are installed, it will probably be more helpful if each is given a more meaningful name, e.g., relating to the use to which amplifier is being put.

Click the **Reset** button to reset the page to the previous state if any changes have been made but not uploaded. Click the **Upload** button to transfer any changes to the amplifier.

Server Ports: in the vast majority of installations, the network parameters in this tab will not need adjustment. However, they are likely to become relevant if the MA80E is connected to an existing IT network. The correct settings for these items will vary from one installation to another, and we recommend that the network administrator is consulted as to the appropriate values.

HTTP Port – this is the virtual port that a browser will connect to. The default is universally “80”. It is sometimes changed for firewalling or “security by obscurity” reasons. If this is the case, the value has to be specified in the browser URL with a colon, eg. `http://cloud.co.uk:9000/` would be required if the HTTP port was set to 9000.

Bridge Port – this is the TCP/IP port used by the MA80E’s Ethernet to Serial Bridge functionality. See xxx for more details.

TCP Parser Port - this is the TCP/IP port used to receive serial control commands via Ethernet (instead of via the RS-232 port)

UDP Parser Port – this is the port used to receive serial control commands via the **UDP layer of TCP/IP**. This is useful for broadcast and multicast control applications.

Multicast Address – this is the address of the multicast group to be used for serial commands via UDP, if the **Multicast** switch is set to **On**.

Save/Restore

Select **Save/Restore** from the menu to open the **Save/Restore Settings** page. This lets you save the current unit settings to a file and also to reload the settings into the MA80E amplifier. This feature will be particularly useful when installing a system with several MA80Es, all of which need to be configured similarly.

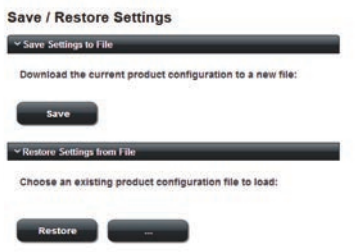

Under the **Save Settings to File** tab, click **Save** to download the current MA80E settings to the computer or other device being used to access the web pages. The browser will treat the file in the same manner as all downloadable files, and will probably present a warning message: an example is shown below (using Mozilla Firefox running under Windows 7):

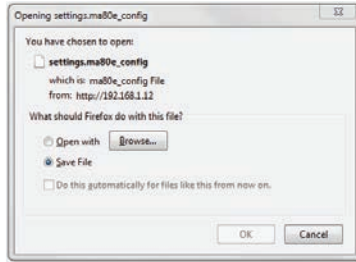

The file will always be called `settings.ma80e_config` and your device will save it to the default folder used for downloads.

To load a previously saved settings file into the MA80E, open the **Restore Settings from File** tab, and click the `...` button. This will open a standard file window: navigate to the settings file and select it. Click **Restore** to upload the settings into the amplifier: a confirmation message will be given when the upload is complete.

Device Info

Select **Device Info** from the menu to open the **Device Information** page.

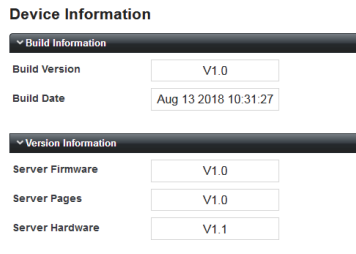

This is an “Engineering” page which gives details of the versions of the various firmware elements in the MA80E.

MA80E SERIAL CONTROL

The MA80E is equipped with a bi-directional RS-232 serial interface.

As a receiver, the interface permits external control of almost every MA80E function, and largely replicates the facilities available through the browser interface. The MA80E appears as a DCE (Data Communications Equipment) device to controlling equipment. As the controlling device will probably be configured as a DTE device, this requires the use of a straight (uncrossed) cable with the Tx (Data Transmit) pins at the two cable ends connected to each other and the Rx pins (Data Receive) similarly connected to each other.

The full RS-232 protocol is beyond the scope of this manual, but it can be downloaded from www.cloud.co.uk.

This chapter provides only serial port details and an abridged serial command list

Pinout

The rear panel RS232 connector is a 3-pin, 3.5 mm-pitch screw-terminal connector. The pinout is shown in the table:

PIN	LABEL	FUNCTION
1	0V	Ground
2	Rx	Data transmit (to control system)
3	Tx	Data receive (from control system)

Note that not all control systems interpret "Tx" and "Rx" the same way, and the installer should check whether pins 2 and 3 should be "crossed" within the cable.

Port parameters:

PARAMETER	VALUE/SETTING
Data type:	RS-232 serial
Data speed	4800/9600/19200/38400/57600/115200 baud, software-selectable
Word length	8 bits
Parity	None
Stop bits	One

The MA80E is additionally able to receive the same serial commands in the form of TCP/IP data via the **ETHERNET** connector.

Abridged command set

The commands listed in the table below are some of those most commonly required when controlling an MA80E from an AV control system. For all other commands, data requests and responses, please refer to the full RS-232 protocol document.

GENERAL FORMAT	
FUNCTION	COMMAND (ASCII)
Enable input source selection	<B1 . IS , E / >
Disable input source selection	<B1 . IS , D / >
Select input source(s) to x (see Example 1)	<B1 , Sx / >
Enable Line x level control	<B1 . Lx , E / >
Disable Line x level control	<B1 . Lx , D / >
Increase Line Input x level by m dB	<B1 . Lx . LUm / >
Decrease Line Input x level by n dB	<B1 . Lx . DUn / >
Enable output level control	<B1 . OL , E / >
Disable output level control	<B1 . OL , D / >
Mute output	<B1 , M / >
Unmute output	<B1 , O / >
Increase Master Line level by m dB	<B1 . LUm / >
Decrease Master line level by n dB	<B1 . LDn / >

Examples:

1. Input Selection:

Following the principle of the web browser pages, most of the audio control functions need to be enabled for external control before adjustment, if they are not already enabled. The first of the two serial commands shown below enables input selection for external control (in case, via the serial port).

EXAMPLE	COMMAND (ASCII)
Enable input selection	<B1 . IS , E / >
Select input source	<B1 , Sx / >

The value of x in the Select input source command is as follows:

x	Result
0	Both inputs off
1	Line 1 only
2	Line 2 only
3	Line 1 + Line 2 (mixed)

2. Input Levels:

Input levels can either be set to an absolute value (in dBs), or increased/decreased by a specified number of dBs. Either may be defined in steps of 1 dB.

For absolute levels, the number of dBs corresponds to attenuation rather than gain, thus 0 dB is maximum level and at -90 dB the zone is muted.

To alter the Zone level by a specified amount, the additional ASCII characters 'U' (up) or 'D' (down) are added to the string. The values of m and n are the number of one-dB steps (0 to 90) up or down respectively. A command to increment the level by a number of dBs greater than the current attenuation will set the level to maximum. Similarly, a command that would decrement the level below 90 dB attenuation will mute the Zone output.

EXAMPLE	COMMAND (ASCII)
Enable Line 1 level control	<B1 . L1 , E / >
Set Line 1 level to -12 dB	<B1 . L1 , L12 / >
Reduce level of Input 1 by 10 dB	<B1 . L1 , LD10 / >
Increase level of Input 1 by 6 dB	<B1 . L1 , LU6 / >

3. Output level

Output levels are set in the same manner as input levels:

EXAMPLE	COMMAND (ASCII)
Enable Output level control	<B1 . OL , E / >
Set Output level to -8 dB	<B1 , L8 / >
Reduce Output level by 3 dB	<B1 , LD3 / >
Increase Output level by 6 dB	<B1 , LU6 / >

Using the MA80E as an Ethernet-to-serial bridge

The MA80E may be used as an Ethernet-to-serial bridge. Many AV control systems now transmit serial data strings in TCP/IP format via an Ethernet interface, rather than from an RS-232 port. However, some equipment – projectors and other display devices, for example – only accept serial control via an RS-232 port.

The MA80E is able to receive serial data at the Ethernet port and re-transmit it from the RS-232 port, and thus act as an Ethernet-to-serial converter or bridge.

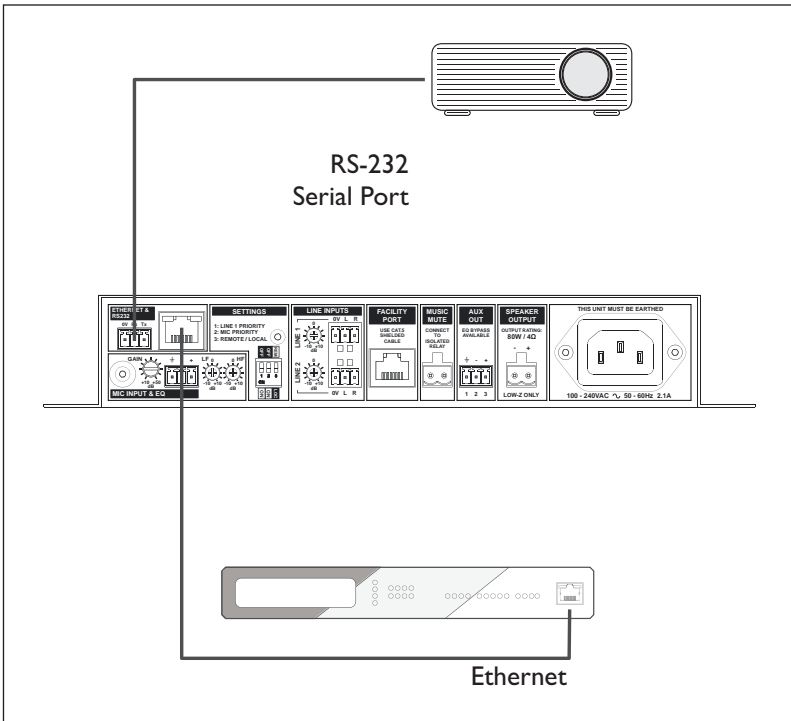

This function uses the MA80E’s virtual CDI port, whose address has the default value of 4998. If the controlling device is only able to support remote ports in a certain address range (i.e., not including 4998), the port address can be changed on the **Network Configuration** page of the browser interface (select **Config** > **Network**).

APPENDIX

PCB layout diagram

To access the internal PCB, disconnect the amplifier from its AC power source* and remove the six screws securing the top cover; remove the cover.

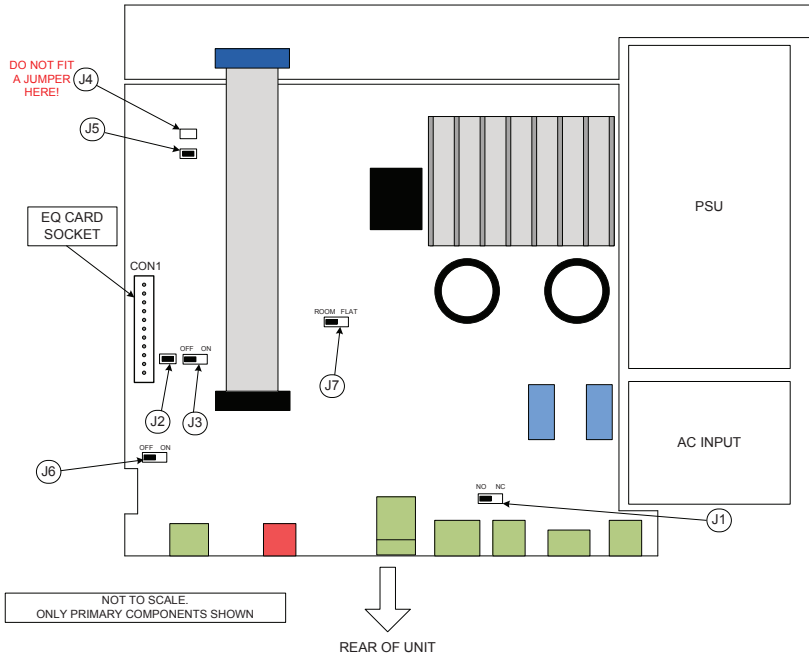

*Note that if the optional conduit adaptor plate has been fitted, replacing the IEC receptacle, this may necessitate isolating the mains circuit to which the amplifier is connected.

Table of internal jumpers and default settings

JUMPER	PURPOSE	OPTIONS	DEFAULT
J1	For factory use only – do not fit jumpers here	Present or Absent	Absent
J2			
J3			
J4	Auto Power Down (APD)	Present = APD Off Absent = APD On	APD Off
J5	Music Mute	N/O or N/C	N/O
J6	Phantom Power	On or Off	Off

Summary of rear panel DIP switch functions

DIP SWITCH		POSITION	FUNCTION
1	LINE 1 PRIORITY	OFF = PRIORITY OFF	In LOCAL mode (ref SW3), the signals at LINE 1 and LINE 2 are mixed together, unless software control of source selection is enabled. In REMOTE mode, LINE 1 or LINE 2 is selected by the MUSIC SOURCE switch on an RSL plate or LM-2 module connected to the Facility Port, unless software control of source selection is enabled.
		ON = PRIORITY ON	A signal at LINE 1 input has priority over that at LINE 2: LINE 2 is automatically muted.
2	MIC PRIORITY	OFF = PRIORITY OFF	The signal at the microphone input will be mixed with the music channel (Line Inputs plus Facility Port input).
		ON = PRIORITY ON	The signal at the microphone input has priority over both Line inputs: the signals at the Line Inputs will be muted. Any input connected via the Facility Port will also be muted.
3	REMOTE/LOCAL	OFF = LOCAL	The output level of the selected source(s) is at maximum volume, unless software control of output level is enabled. The two inputs are mixed together, unless software control of input source is enabled.
		ON = REMOTE	The output level of the selected source(s) is controlled by the level control on the remote plate or module connected at the Facility Port, unless software control of output level is enabled. If an RSL Series plate or LM-2 module is in use, the Music Source control can select either LINE 1 or LINE 2, unless software control of source is enabled.

Note: default settings are in **BOLD** text.

Troubleshooting – STATUS LED indications

The MA80E is well protected against errors in speaker wiring and other inappropriate operating conditions. The speaker output is monitored for excessively low impedance (i.e., a short circuit) and for the presence of DC. The internal temperature of the amplifier’s power stage is also monitored.

In the event of any of the pre-defined safety conditions being exceeded, the amplifier will enter Protection mode, and will cease passing audio. In this case, the cause of the problem should be investigated and resolved (see below) and the amplifier power-cycled to exit Protection mode.

The front panel **STATUS LED**  provides information about the amplifier’s current state and will flash if Protection mode has been triggered.

INDICATION	STATUS	CAUSE
Steady green	Normal	No fault – normal operation
Steady red	APD Mode	Standby mode (if enabled)
Flashing green	Protection Mode	Over-temperature sensed or over-current protection triggered
Flashing red		DC detected at output terminals

Fault resolution

Over- temperature (STATUS LED flashes green):

Check that the amplifier has sufficient airflow around the casing (e.g., it is not covered by ceiling insulation material or similar), and that the ambient temperature at the amplifier location is not above +40°C. Power-cycle the amplifier to cancel Protection mode.

Over-current protection (STATUS LED flashes green):

Over-current protection will be triggered if the load at the output terminals is less than 4 ohms; clearly this includes the possibility of a short-circuit. The amplifier needs to have an input signal and the level control(s) turned up for this protection to operate. Investigate the output wiring and check for a faulty loudspeaker. Power-cycle the amplifier to cancel Protection mode.

DC protection (STATUS LED flashes red):

DC protection will be triggered if one of the speaker terminals is shorted to ground. Check the loudspeaker wiring. It can also be triggered when the input signal contains high amplitude, low frequency components, such as may be caused by clicks and

pops from other connected equipment. Check that the rear panel GAIN controls **2** and **4** and front panel LEVEL controls **1**, **2** and **3** are not set too high. It may be necessary to enable the high-pass protection filter (via the web interface) to prevent false triggering. Power-cycle the amplifier to cancel Protection mode.

EMC considerations

The MA80E amplifier fully conforms to the relevant electromagnetic compatibility (EMC) standards and is technically well behaved. You should experience no problems interfacing units to other items of equipment and under normal circumstances, no special precautions need to be taken. If the unit is to be used in close proximity to potential sources of HF disturbance such as high power communication transmitters, radar stations and the like, it is suggested that input signal leads be kept as short as possible. Always use balanced interconnections wherever possible. We recommend that the MA80E amplifier is not located in close proximity to a high-power amplifier or similar item of equipment, which may radiate a strong magnetic field from its power transformer.

Earthing

When several mains powered units are connected together via their signal cables, there is a risk of one or more earth loops which may cause an audible hum on the system even with the gain controls set to minimum. The 0 V rail of an MA80E amplifier is directly coupled to the chassis ground. No interconnection problems should be encountered, but if there is any hum or other extraneous noise when source equipment is connected, the situation can generally be remedied by observing the following guidelines:

- Always connect sources using balanced connections wherever possible. Note that, for EMC reasons, the cable screen should be connected at both ends.
- Use audio isolating transformers (readily available from trade suppliers) at the inputs if necessary. These will ensure that the amplifier is electrically isolated from the source equipment.
- The signal source units should be located as close as practical to the amplifier. The metal housings of the various units should not be electrically connected. Try to ensure that all interconnected units, including power amplifiers, are connected to a common power source to ensure a common ground is provided.

Technical specifications

LINE INPUTS	
Frequency Response	+/- 1 dB, 20 Hz to 20 kHz
THD+N	<0.025% @ 1 kHz, full power (22 kHz bandwidth)
Sensitivity	195 mV (-12 dBu) to 2.0 V (+8 dBu)
Input Gain Control	20 dB range
Input Impedance	47 kohms (unbalanced)
Headroom	10 dB
Noise	<-90 dB rms (22 kHz bandwidth)
FACILITY INPUT	
Sensitivity	0.775 V (0 dBu)
Input Impedance	10 kohms (balanced)
Headroom	10 dB
Noise Gate	-55 dBu
EQUALISATION	
Music EQ (front panel)	HF: +/-10 dB @ 10 kHz; LF: +/-10 dB @ 50 Hz
Mic EQ (rear panel)	HF: +/-10 dB @ 5 kHz; LF: +/-10 dB @ 100 Hz
Room EQ (via web pages)	7-band parametric EQ with optional low and high shelf
Protection EQ (via web pages)	Fourth-order high-pass filter, 40 Hz – 20 kHz
Speaker EQ (via web pages)	5-band parametric EQ
MAIN OUTPUT	
Output Power (4 ohms)	80 W (1 kHz continuous sine wave)
Amplifier protection	Fixed level signal limiter Protection against DC, PSU overcurrent, amplifier overcurrent, over-temperature, supply voltage under/over-voltage Resettable internal breaker (no fuses)
AUXILIARY OUTPUT	
Max output level	0.775 V (0 dBu)
GENERAL	
Power Input	Universal type, 100 V to 240 V, 50 to 60 Hz

Power consumption	Standby ¹	2.917 W, 9.66 VA
	Idle ²	5.04 W, 12.66 VA
	1/8 th Power (4 ohms) ³	17.21 W, 31.52 VA
	1/3 rd Power (4 ohms) ⁴	33.94 W, 56.47 VA
Heat Loss	Standby ¹	10.5 KJ/hr (10.0 BTU/hr)
	Idle ²	18.1 KJ/hr (17.2 BTU/hr)
	1/8 th Power (4 ohms) ³	27.0 KJ/hr (25.6 BTU/hr)
	1/3 rd Power (4 ohms) ⁴	27.6 KJ/hr (26.2 BTU/hr)
Dimensions (w x h x d)	Net	260 mm x 41 mm x 180 mm 10.24" x 1.61" x 7.09"
	Shipping	400 mm x 145 mm x 255 mm 15.75" x 5.71" x 10.0"
Weight	Net	1.35 kg
	Shipping	2.05 kg

Notes re Power Consumption and Heat Loss measurements:

All measurements at 230 VAC 50 Hz power input

1. Standby: amplifier in standby state (**STATUS** LED steady red)
2. Idle: amplifier not in standby state (**STATUS** LED steady green), but no audio output
3. 1/8th. Power: constant sound level at 10 W output (audio mainly clean, only occasional clipping)
4. 1/3rd. Power: constant sound level at 27 W output (audio beginning to become compressed, limited or heavily clipped)

Cloud

www.cloud.co.uk

Cloud

www.cloudusa.pro

MADE IN BRITAIN 